

MEDIUM VOLTAGE

HEAT-SHRINK
COLD-SHRINK
TERMINATIONS
AND JOINTS.
SEPARABLE
CONNECTORS,
SHEATHS AND TAPES.

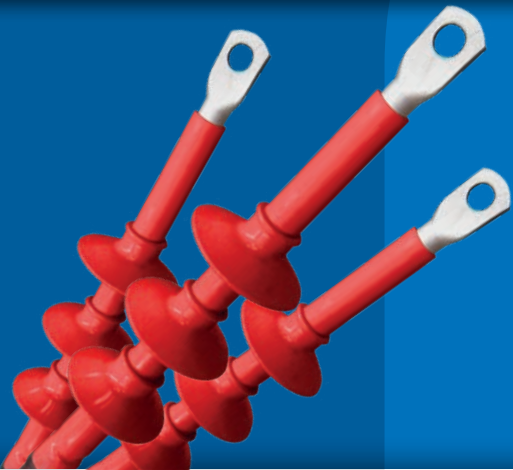





**Ray
tech**

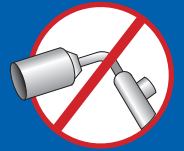

MEDIUM VOLTAGE
COLD-SHRINK





Electrical performance:

CEI 20-24 • CEI 20-62/1 • HD 629-1

Kit composition:

Three single core terminations

RANGES OF APPLICATION

For single core cables type:

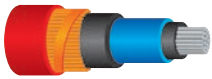

**Extruded cable
copper wire screened**



**Extruded cable
copper tape screened**

TEMPERATURES



105°C

Working temperature



140°C

Max overload temperature



300°C

Short circuit temperature

To select the right termination:

Cable code, section in mm², nominal voltage, indoor or outdoor installation.

COLD-SHRINK TERMINATIONS FOR INDOOR USE

Silicone rubber terminations with electric field control. For extruded cables up to **18/30 kV (Um 36 kV)**.

Cold-shrink technology is based on pre-dilated insulating sheaths on a removable spiral support, which is removed without tools during installation to allow for complete covering of the cable insulation. The Raytech silicone sheath, supplied pre-expanded, is flame retardant, is highly anti-tracking, has very high elastic characteristics, is able to maintain pressure on the cable during operation, is water-repellent and is extremely sturdy. Raytech terminations are suitable for indoor, very compact applications, with a smooth structure and complete with all components. Each kit contains 3 single core indoor terminations. The components are cold-installed without tools, unwinding the pigtail wire.



For cables

(A)RG16HIR12 and (A)RG7HIR insulation thickness FULL

Product	Item	U _{max} (kV)	∅ on insulation (mm)	∅ on external sheath (mm)	Conductor cross section (mm ²)	L (mm)
AUTO 10/120-I	10120-I-AUTO	12	15,3 - 20,2	24,6 - 29,6	50 - 120	320
AUTO 10/240-I	10240-I-AUTO		18,7 - 25,6	28,0 - 35,8	95 - 240	
AUTO 10/630-I	10630-I-AUTO		28,2 - 37,8	38,5 - 49,4	300 - 630	
AUTO 15/70-I	1570-I-AUTO	17,5	16,3 - 19,2	25,6 - 28,7	35 - 70	
AUTO 15/240-I	15240-I-AUTO		19,2 - 27,8	28,7 - 38,1	70 - 240	
AUTO 15/630-I	15630-I-AUTO		27,8 - 40,0	38,1 - 52,1	240 - 630	
AUTO 20/50-I	2050-I-AUTO	24	17,3 - 19,5	27,8 - 29,0	25 - 50	
AUTO 20/185-I	20185-I-AUTO		19,5 - 27,4	29,0 - 37,8	50 - 185	
AUTO 20/630-I	20630-I-AUTO		29,8 - 42,0	40,2 - 54,2	240 - 630	
AUTO 30/95-I	3095-I-AUTO	36	22,3 - 27,9	33,5 - 38,5	22 - 95	
AUTO 30/120-I	30120-I-AUTO		29,4 - 31,0	37,3 - 41,2	120 - 150	
AUTO 30/400-I	30400-I-AUTO		30,6 - 40,3	39,0 - 51,3	150 - 400	

For cables RG7HIM1 insulation thickness LOW

Product	Item	U _{max} (kV)	∅ on insulation (mm)	∅ on external sheath (mm)	Conductor cross section (mm ²)	L (mm)
AUTO 20/50-I	2050-I-AUTO	24	17,0 - 19,0	23,3 - 25,3	25 - 70	320
AUTO 20/185-I	20185-I-AUTO		21,0 - 28,0	26,7 - 34,5	95 - 240	
AUTO 20/630-I	20630-I-AUTO		28,0 - 41,0	34,6 - 48,3	240 - 630	
AUTO 30/95-I	3095-I-AUTO	36	25,0 - 27,0	31,2 - 33,4	50 - 120	410
AUTO 30/120-I	30120-I-AUTO		28,0 - 29,0	32,3 - 35,0	150 - 185	
AUTO 30/400-I	30400-I-AUTO		28,0 - 40,0	34,6 - 47,9	150 - 500	



For cables CPR RG26H1M16 12/20 kV (U_{max} 24 kV)

Product Item	Nominal voltage U _{max} (kV)	∅ on insulation (mm)	∅ on external sheath (mm)	Conductor cross section (mm ²)	L (mm)
AUTO 20/50-I 2050-I-AUTO	24	17	26	25	320
		17	27	35	
		18	28	50	
AUTO 20/185-I 20185-I-AUTO	24	19	29	70	320
		20,6	30	95	
		22	32	120	
		23,7	34	150	
AUTO 20/630-I 20630-I-AUTO	24	25	36	185	320
		27,8	39	240	
		30,8	43	300	
		33	46	400	
		37	49	500	
		40	51	600	

For cables CPR RG26H1M16 18/30 kV (U_{max} 36 kV)

Product Item	Nominal voltage U _{max} (kV)	∅ on insulation (mm)	∅ on external sheath (mm)	Conductor cross section (mm ²)	L (mm)
AUTO 30/95-I 3095-I-AUTO	36	25,6	32	35	410
		25	35	50	
		25	36	70	
		26	37	95	
		27	38	120	
AUTO 30/120-I 30120-I-AUTO	36	28,2	39	150	410
		29,2	41	185	
		31,5	43	240	
AUTO 30/400-I 30400-I-AUTO	36	34,5	46	300	410
		37	48	400	
		41	52	500	

The accessories for cables in accordance with CPR, type RG26H1M16 (Italian designation), are suitable for

- Cables with copper conductors
- Special thermoplastic sheath
- Red copper wire screen
- High modulus rubber insulation

★ ADVANTAGES

- Rapid installation for lower labour cost
- Highly reliable and safe for operators
- Installation without heating and without tools





Electrical performance:

CEI 20-24 • CEI 20-62/1 • HD 629-1

Kit composition:

Three single core terminations

RANGES OF APPLICATION

For single core cables type:

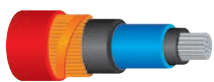

**Extruded cable
copper wire screened**



**Extruded cable
copper tape screened**

TEMPERATURES



105°C

Working temperature



140°C

Max overload temperature



300°C

Short circuit temperature

To select the right termination:

Cable code, section in mm², nominal voltage, indoor or outdoor installation.

COLD-SHRINK TERMINATIONS FOR OUTDOOR USE

Silicone rubber outdoor terminations with electric field control and bell-shaped insulators. For extruded cables up to **18/30 kV (Um 36 kV)**.

The Raytech silicone sheath, supplied pre-expanded, is flame retardant, is highly anti-tracking, has very high elastic characteristics, is able to maintain pressure on the cable during operation, is water-repellent and is extremely sturdy. With pre-dilated silicone fins on a spiral support for modular installation of the outdoor accessory for upside-down installation. Raytech terminations are suitable for external, very compact applications, complete with all components. Each kit contains 3 single core outdoor terminations. The components are cold-installed without tools, unwinding the pigtail wire.

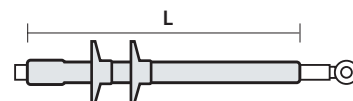

For cables

(A)RG16HIR12 and (A)RG7HIR insulation thickness FULL

Product	Item	U _{max} (kV)	∅ on insulation (mm)	∅ on external sheath (mm)	Conductor cross section (mm ²)	L (mm)
AUTO 10/120-E	10120-E-AUTO	12	15,3 - 20,2	24,6 - 29,6	50 - 120	410
AUTO 10/240-E	10240-E-AUTO		18,7 - 25,6	28,0 - 35,8	95 - 240	410
AUTO 10/300-E	10300-E-AUTO		28,0 - 29,0	35,5 - 39,0	300	410
AUTO 10/630-E	10630-E-AUTO	17,5	28,3 - 37,8	38,5 - 49,4	300 - 630	420
AUTO 15/70-E	1570-E-AUTO		16,3 - 19,2	25,6 - 28,7	35 - 70	410
AUTO 15/240-E	15240-E-AUTO		19,2 - 27,8	28,7 - 38,1	70 - 240	410
AUTO 15/300-E	15300-E-AUTO	24	30,0 - 31,0	38,0 - 41,0	300	410
AUTO 15/630-E	15630-E-AUTO		30,4 - 40,0	40,2 - 52,1	300 - 630	420
AUTO 20/50-E	2050-E-AUTO		17,3 - 19,5	27,8 - 29,0	25 - 50	410
AUTO 20/185-E	20185-E-AUTO	36	19,5 - 27,4	29,0 - 37,8	50 - 185	410
AUTO 20/240-E	20240-E-AUTO		27,5 - 31,0	35,7 - 41,0	185 - 240	410
AUTO 20/630-E	20630-E-AUTO		29,8 - 42,0	40,2 - 54,2	240 - 630	420
AUTO 30/95-E	3095-E-AUTO	36	22,3 - 27,9	33,5 - 38,5	25 - 95	680
AUTO 30/120-E	30120-E-AUTO		29,4 - 31,0	37,3 - 41,2	120 - 150	680
AUTO 30/400-E	30400-E-AUTO		30,6 - 40,3	39,0 - 51,3	150 - 400	680

For cables RG7HIM1 insulation thickness LOW

Product	Item	U _{max} (kV)	∅ on insulation (mm)	∅ on external sheath (mm)	Conductor cross section (mm ²)	L (mm)
AUTO 20/50-E	2050-E-AUTO	24	17,0 - 19,0	23,3 - 25,3	25 - 70	410
AUTO 20/185-E	20185-E-AUTO		21,0 - 28,0	26,7 - 34,5	95 - 240	410
AUTO 20/240-E	20240-E-AUTO		28,0 - 31,5	34,6 - 42,0	240 - 300	410
AUTO 20/630-E	20630-E-AUTO	36	31,0 - 41,0	37,4 - 48,3	300 - 630	420
AUTO 30/95-E	3095-E-AUTO		25,0 - 27,0	31,2 - 33,4	50 - 120	680
AUTO 30/120-E	30120-E-AUTO		28,0 - 29,0	32,3 - 35,0	150 - 185	680
AUTO 30/400-E	30400-E-AUTO		28,0 - 40,0	34,6 - 47,9	150 - 500	680

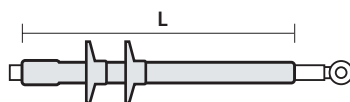

For cables CPR RG26H1M16 12/20 kV (U_{max} 24 kV)

Product Item	Nominal voltage U _{max} (kV)	Ø on insulation (mm)	Ø on external sheath (mm)	Conductor cross section (mm ²)	L (mm)
AUTO 20/50-E 2050-E-AUTO	24	17	26	25	410
		17	27	35	
		18	28	50	
AUTO 20/185-E 20185-E-AUTO	24	19	29	70	410
		20,6	30	95	
		22	32	120	
		23,7	34	150	
AUTO 20/240-E 20240-E-AUTO	24	25	36	185	410
		27,8	39	240	
		30,8	43	300	
AUTO 20/630-E 20630-E-AUTO	24	33	46	400	420
		37	49	500	
		40	51	630	

For cables CPR RG26H1M16 18/30 kV (U_{max} 36 kV)

Product Item	Nominal voltage U _{max} (kV)	Ø on insulation (mm)	Ø on external sheath (mm)	Conductor cross section (mm ²)	L (mm)
AUTO 30/95-E 3095-E-AUTO	36	25,6	32	35	680
		25	35	50	
		25	36	70	
		26	37	95	
		27	38	120	
AUTO 30/120-E 30120-E-AUTO	36	28,2	39	150	680
		29,2	41	185	
		31,5	43	240	
AUTO 30/400-E 30400-E-AUTO	36	34,4	46	300	680
		37	48	400	
		37	48	400	
		41	52	500	

The accessories for cables in accordance with CPR, type RG26H1M16 (Italian designation), are suitable for

- Cables with copper conductors
- Special thermoplastic sheath
- Red copper wire screen
- High modulus rubber insulation

★ ADVANTAGES

- Rapid installation for lower labour cost
- Highly reliable and safe for operators
- Installation without heating and without tools



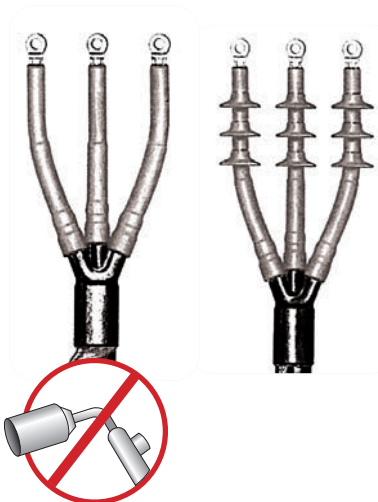

Electrical performance:

CEI 20-24 • CEI 20-62/1 • HD 629-1

RANGES OF APPLICATION

For single core cables type:

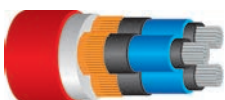

Three-core extruded cable, wire screened

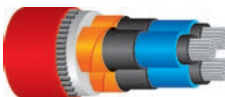

Three-core extruded cable, tape screened, armoured

Note: for three-core cables, low thickness insulation, please contact Raytech.

★ ADVANTAGES

- Rapid installation for lower labour cost
- Highly reliable and safe for operators
- Installing without heating and without tools

THREE-CORE COLD-SHRINK TERMINATIONS FOR INDOOR/OUTDOOR USE

Terminations for armoured and non armoured extruded cables up to **36 kV**

Hybrid technology that provides heat-shrink trifurcation and cold-shrink termination.

For INDOOR use

For NON ARMoured cables

Product	Item	U _{max} 12 kV	U _{max} 17,5 kV	U _{max} 24 kV	U _{max} 36 kV
		sez. (mm ²)	sez. (mm ²)	sez. (mm ²)	sez. (mm ²)
AUTO 20/50-I-3	2050-I-3-AUTO	50 - 120	35 - 70	25 - 50	-
AUTO 20/185-I-3	20185-I-3-AUTO	95 - 240	70 - 240	50 - 185	-
AUTO 20/630-I-3	20630-I-3-AUTO	300 - 500	240 - 400	240 - 300	-
AUTO 30/95-I-3	3095-I-3-AUTO	-	-	-	25 - 95
AUTO 30/240-I-3	30240-I-3-AUTO	-	-	-	120 - 240

For ARMoured cables

Product	Item	U _{max} 12 kV	U _{max} 17,5 kV	U _{max} 24 kV	U _{max} 36 kV
		sez. (mm ²)	sez. (mm ²)	sez. (mm ²)	sez. (mm ²)
AUTO 20/50-I-3ARM	2050-I-3ARM-AUTO	50 - 120	35 - 70	25 - 50	-
AUTO 20/185-I-3ARM	20185-I-3ARM-AUTO	95 - 240	70 - 240	50 - 185	-
AUTO 20/630-I-3ARM	20630-I-3ARM-AUTO	300 - 500	240 - 400	240 - 300	-
AUTO 30/95-I-3ARM	3095-I-3ARM-AUTO	-	-	-	25 - 95
AUTO 30/240-I-3ARM	30240-I-3ARM-AUTO	-	-	-	120 - 240

For OUTDOOR use

For NON ARMoured cables

Product	Item	U _{max} 12 kV	U _{max} 17,5 kV	U _{max} 24 kV	U _{max} 36 kV
		sez. (mm ²)	sez. (mm ²)	sez. (mm ²)	sez. (mm ²)
AUTO 20/50-E-3	2050-E-3-AUTO	50 - 120	35 - 70	25 - 50	-
AUTO 20/185-E-3	20185-E-3-AUTO	95 - 240	70 - 240	50 - 185	-
AUTO 20/630-E-3	20630-E-3-AUTO	300 - 500	240 - 400	240 - 300	-
AUTO 30/95-E-3	3095-E-3-AUTO	-	-	-	25 - 95
AUTO 30/240-E-3	30240-E-3-AUTO	-	-	-	120 - 240

For ARMoured cables

Product	Item	U _{max} 12 kV	U _{max} 17,5 kV	U _{max} 24 kV	U _{max} 36 kV
		sez. (mm ²)	sez. (mm ²)	sez. (mm ²)	sez. (mm ²)
AUTO 20/50-E-3ARM	2050-E-3ARM-AUTO	50 - 120	35 - 70	25 - 50	-
AUTO 20/185-E-3ARM	20185-E-3ARM-AUTO	95 - 240	70 - 240	50 - 185	-
AUTO 20/630-E-3ARM	20630-E-3ARM-AUTO	300 - 500	240 - 400	240 - 300	-
AUTO 30/95-E-3ARM	3095-E-3ARM-AUTO	-	-	-	25 - 95
AUTO 30/240-E-3ARM	30240-E-3ARM-AUTO	-	-	-	120 - 240

MEDIUM VOLTAGE TESTING DETAILS FOR TERMINALS AND JOINTS UP TO 36 kV.

TEST	TEST METHOD (VOLTAGES IN kV)	MAXIMUM VOLTAGE PER CABLE UM (kV)					RESULTS
		7,2	12	17,5	24	36	
INDUSTRIAL FREQUENCY AC	a) 1 min. (dry)	27	35	45	55	75	Neither perforations nor discharges
	b) 1 min. (in the rain)	27	35	45	55	75	
	c) 4 h.	14	24	36	48	73	
PARTIAL DISCHARGES	PE, XLPE, EPR, PVC (voltages in kV)	4,5	7,5	10,9	15	22,5	< 3 pC
		7,2	12	17,5	24	-	< 20 pC
IMPULSE	a) 10 positive 10 negative 1,2/50 μ s (voltages in kV)	60	75	95	125	170	Neither perforations nor discharges
	b) 10 positive 10 negative 1,2/50 μ s (voltages in kV)	70	95	110	150	200	
THERMAL CYCLES WITH APPLIED VOLTAGE	a) 63 cycles of 5 h. of heating, 3 h. of air cooling	-	-	-	-	-	Neither perforations nor discharges
	b) 63 cycles of 5 h. of heating, 3 h. of water cooling (1m of water head)	-	-	-	-	-	
	Extruded cable and non-migrant mixture paper cable	9	15	22	30	45	
	Migrant mixture paper cable	6,5	11	15	22	32	
THERMAL SHORT-CIRCUIT TEST	a) short-circuit of 1s f/t at maximum temperature specified for the cable	-	-	-	-	-	No visible damage
	b) short-circuit of 1s f/t at maximum temperature specified for the cable	-	-	-	-	-	
DIRECT CURRENT	30 min	28	48	72	96	144	Neither perforations nor discharges
HUMIDITY TEST WITH APPLIED VOLTAGE	a) 100 h. in saturated air	4,5	7,5	10,9	15	22,5	Neither perforations nor discharges, nor visible carbonisation nor erosion
	b) 1000 h. in saturated air	4,5	7,5	10,9	15	22,5	
DYNAMIC SHORT-CIRCUIT TEST	63 kA - Standard	-	-	-	-	-	No visible damage
	125 kA - High Current	-	-	-	-	-	
IMPACT	Fall from a height of 2 m at a weight of 4 kg, 6 times (only reinforced joints)	-	-	-	-	-	
SALTY FOG TEST WITH APPLIED VOLTAGE	1h of sealing salinity 224 kg/m ³ (voltages in kV)	4,5	7,5	10,9	15	22,5	No discharge

TESTING SEQUENCE

Indoor terminations 1a,2,3a, 4a,2,5, 4a, 1c, 3a,6,7a, 8

Outdoor terminations 1b, 2, 3b, 4a,2, 5,4a, 2, 1c,3b, 6,7b, 8, 10

Joints 9, 1a,2,3b,4a,2,5, 4b,2,5, 4b,2,1c,3b, 6,8



Electrical performance:

CEI 20-24 • CEI 20-62/1 • HD 629-1

RANGES OF APPLICATION

For single core cables type:

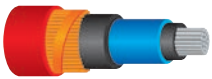

**Extruded cable
copper wire screened**



**Extruded cable
copper tape screened**

TEMPERATURES



105°C

Working temperature



140°C

Max overload temperature



300°C

Short circuit temperature

SINGLE CORE COLD-SHRINK JOINTS

Monoblock joints for extruded cables up to **18/30 kV (Um 36 kV)**.

Suitable for outdoor, underground and even underwater applications. Very compact and complete with all components. Each kit contains 1 single core joint. Each joint component is pre-dilated on a spiral support and is extremely easy to remove for fast, safe installation without the use of any tools or heating.

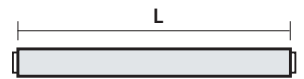

For cables

(A)RG16HIR12 and (A)RG7HIR insulation thickness FULL

Product	Item	U _{max} (kV)	∅ on insulation (mm)	∅ on external sheath (mm)	Conductor cross section (mm ²)	L (mm)
JMAUTO 20/95-1	JM-2095-1-AUTO	12	17 - 23	26 - 33	70 - 150	550
JMAUTO 20/240-1	JM-20240-1-AUTO		22 - 32	33 - 39	185 - 400	600
JMAUTO 20/400-1	JM-20400-1-AUTO		32 - 36	42 - 48	400 - 630	600
JMAUTO 20/95-1	JM-2095-1-AUTO	17,5	17 - 23	26 - 33	50 - 150	550
JMAUTO 20/240-1	JM-20240-1-AUTO		22 - 32	33 - 39	150 - 300	600
JMAUTO 20/400-1	JM-20400-1-AUTO		32 - 36	42 - 48	400 - 500	600
JMAUTO 20/95-1	JM-2095-1-AUTO	24	17 - 23	26 - 33	25 - 95	550
JMAUTO 20/240-1	JM-20240-1-AUTO		22 - 32	33 - 39	120 - 240	600
JMAUTO 20/400-1	JM-20400-1-AUTO		32 - 36	42 - 48	300 - 400	600
JMAUTO 30/95-1	JMAUTO 30/95-1	36	25 - 29	31,2 - 38,3	50 - 95	750
JMAUTO 30/185-1	JMAUTO 30/185-1		27 - 31	33,4 - 42	120 - 185	750

For cables RG7HIM1 insulation thickness LOW

Product	Item	U _{max} (kV)	∅ on insulation (mm)	∅ on external sheath (mm)	Conductor cross section (mm ²)	L (mm)
JMAUTO 20/95-1	JM-2095-1-AUTO	24	17 - 23	26 - 33	25 - 120	550
JMAUTO 20/240-1	JM-20240-1-AUTO		22 - 32	33 - 39	120 - 300	600
JMAUTO 20/400-1	JM-20400-1-AUTO		32 - 36	42 - 48	300 - 500	600

★ ADVANTAGES

- Rapid installation for lower labour cost
- Highly reliable and safe for operators
- Installing without heating and without tools
- Reduced size of the joint and joint bay dimensions
- Minimized possibility of error

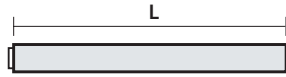

For cables CPR RG26H1M16 12/20 kV (U_{max} 24 kV)

Product Item	Nominal voltage U _{max} (kV)	Ø on insulation (mm)	Ø on external sheath (mm)	Conductor cross section (mm ²)	L (mm)
JMAUTO 20/95-1 JM-2095-1-AUTO	24	17	26	25	550
		17	27	35	
		18	28	50	
		19	29	70	
		20,6	30	95	
JMAUTO 20/240-1 JM-20240-1-AUTO	24	22	32	120	600
		23,7	34	10	
		25	36	185	
JMAUTO 20/400-1 JM-20400-1-AUTO	24	27,8	39	240	600
		30,8	43	300	



Single core cold-shrink joints (U_{max} 24 kV)

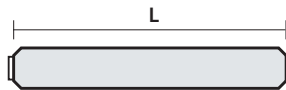

For cables CPR RG26H1M16 18/30 kV (U_{max} 36 kV)

Product Item	Nominal voltage U _{max} (kV)	Ø on insulation (mm)	Ø on external sheath (mm)	Conductor cross section (mm ²)	L (mm)
JMAUTO 30 / 95-1 JMAUTO 30/95-1	36	25,6	32	35	750
		25	35	50	
		25	36	70	
		26	37	95	
JMAUTO 30 / 185-1 JMAUTO 30/185-1	36	27	38	120	750
		28,5	39	150	
		29,5	41	185	



Single core cold-shrink singleblock joints (U_{max} 36 kV)

The accessories for cables in accordance with CPR, type RG26H1M16 (Italian designation), are suitable for

- Cables with copper conductors
- Special thermoplastic sheath
- Red copper wire screen
- High modulus rubber insulation

Installation sequence

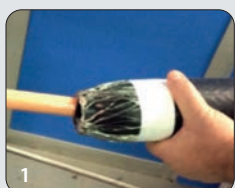

1 The body of the joint carries the integrated shield and outer sheath.



2 The joint is fitted on the connected cable.

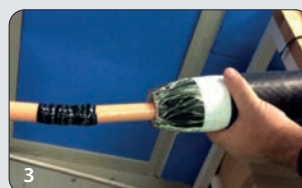

3 Position at the centre of the connection and collapsed on the cable removing the inner support.



4 The joint is completed and can be used immediately.

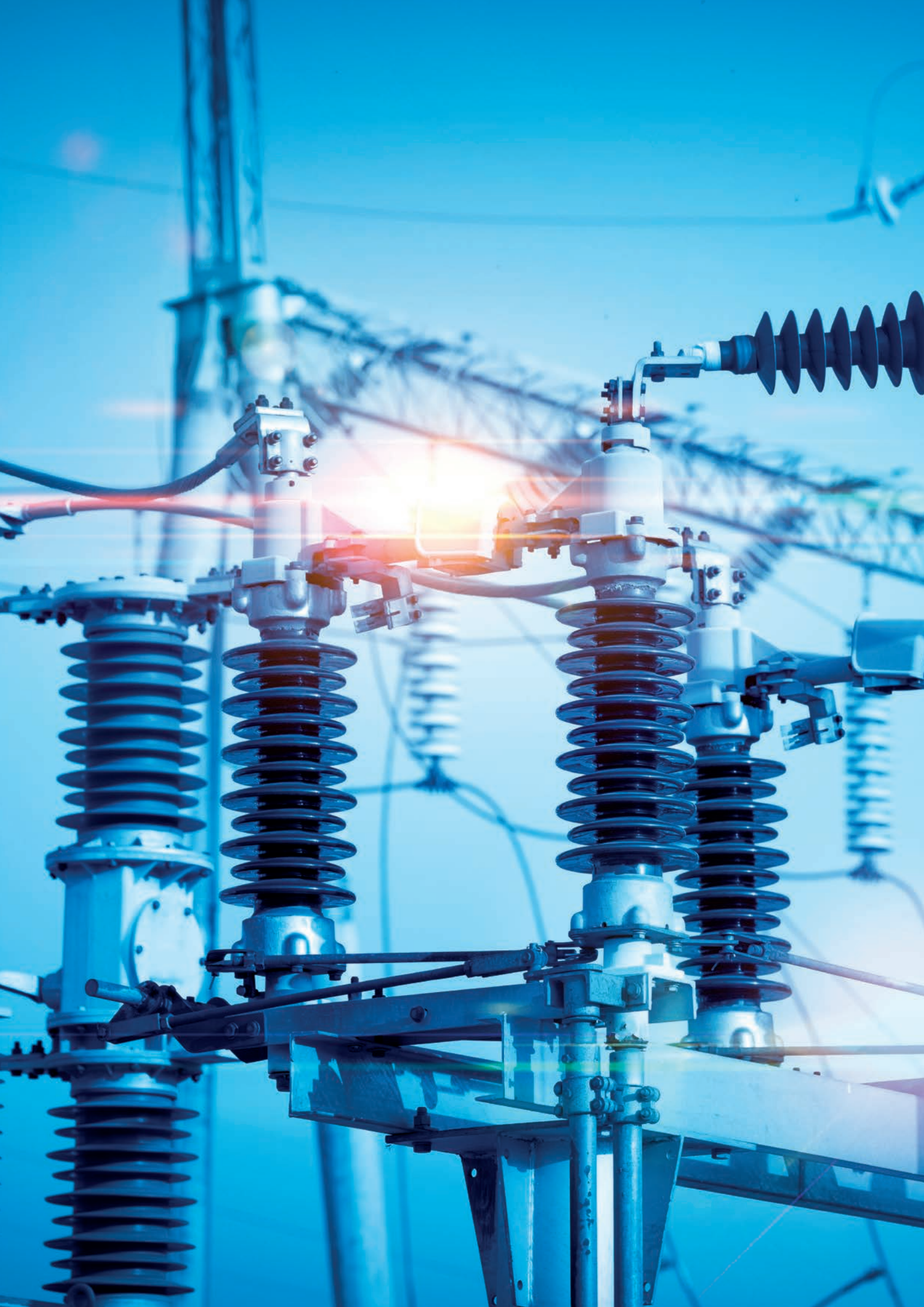

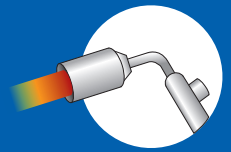

MEDIUM VOLTAGE
HEAT-SHRINK





TERMINATIONS AND JOINTS HEAT-SHRINK



QUICK PREPARATION



THEY DO NOT REQUIRE A PARTICULAR MANPOWER



LOW NUMBER OF COMPONENTS



WITH NO SHELF LIFE



CAN BE INSTALLED IN ALL ENVIRONMENTAL CONDITIONS



HIGH FLEXIBILITY OF USE



EXTREMELY COMPACT



EASY CUSTOMIZATION



ACCESSORIES HEAT-SHRINK

ELECTRIC FIELD CONTROL

The control of the electric field is achieved by means of polymers charged with metal oxides with a non-linear characteristic; in the terminations the outer sheaths, designed to get a higher resistance to UV radiation and to electrical tracking, completely cover the cable insulation.

WITHOUT FIELD CONTROL

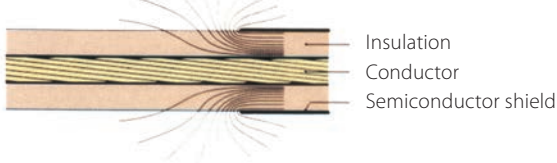



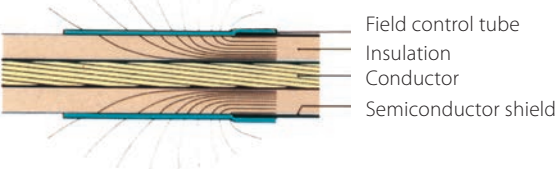

WITH FIELD CONTROL TUBE

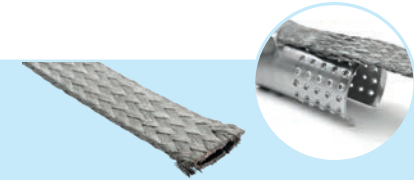

IDENTIFICATION OF COMPLEMENTARY ACCESSORIES

With a few complementary accessories the terminations are suitable for all types of cable:

MV Terminations how to identify and order complementary accessories

Accessory	Abbreviation to add to the product code		Example	
Grounding braid for aluminium tube shields	/H5		THVE 20/A-RC/H5	
Grounding braid with roll spring (only for single core)	/24	For cables (mm ²) up to 25	THVE 20/A-RC/24 THVE 20/B-RC/25 THVE 20/C-RC/26 THVE 20/C-RC/27	
	/25	from 35 to 95		
	/26	from 120 to 300		
	/27	from 400 to 630		
Copper cable terminal	-C	+ Conductor cross section	THVE 20/A-RC-C50	
Aluminium cable terminal	-CA	+ Conductor cross section	THVE 20/A-RC-CA50	
Shear bolt lug	-CPR	+ Conductor cross section	THVE 20/A-RC-CPR50	
Multiple choice	With cable lug and grounding accessory, add codes		THVE 20/A-RC/24-C50	

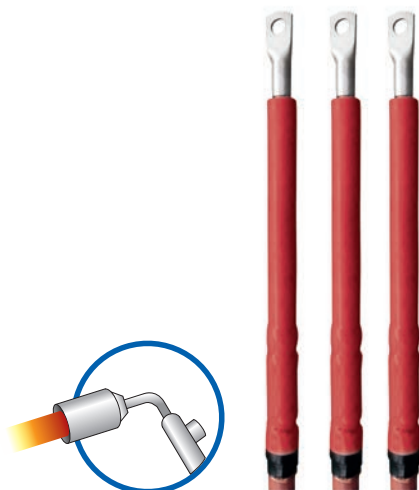

HEAT-SHRINK TERMINATIONS FOR INDOOR USE FOR NON ARMOURED CABLES

Terminations for **SINGLE CORE** extruded cables up to **36 kV**.



For cables (A)RG16HIR12 and (A)RG7HIR insulation thickness **FULL**

Electrical performance:

CEI 20-24 • CEI 20-62/1 • HD 629-1

Kit composition:

Three single core terminations

RANGES OF APPLICATION

For single core cables type:



Extruded cable, copper wire screen



Extruded cable, copper tape screen



Extruded cable, aluminium tube screen

TEMPERATURES



105°C

Working temperature



140°C

Max overload temperature



300°C

Short circuit temperature

Product	Item	Voltage Umax (kV)	Conductor cross section (mm ²)	L (mm)
THVE 6/A-RC	369608-000	7,2	25 - 120	210
THVE 6/B-RC	034189-000		150 - 400	
THVE 6/C-RC	882065-000		500 - 630	
THVE 15/A-RC	906848-000	12	25 - 95	320
THVE 15/B-RC	500365-000		120 - 300	
THVE 15/C-RC	068756-000		400 - 630	
THVE 15/A-RC	906848-000	17,5	25 - 50	320
THVE 15/B-RC	500365-000		70 - 300	
THVE 15/C-RC	068756-000		400 - 800	
THVE 20/A-RC	507698-000	24	25 - 50	320
THVE 20/B-RC	190360-000		70 - 240	
THVE 20/C-RC	485361-000		240 - 630	
THVE 30/A-RC	454523-000	36	35 - 95	430
THVE 30/B-RC	308359-000		120 - 185	
THVE 30/C-RC	651264-000		240 - 500	

For shielded aluminium tube cables, add terminal abbreviation **H5**.

For cables RG7H1M1 Afumex insulation thickness **LOW**

Product	Item	Voltage Umax (kV)	Conductor cross section (mm ²)	L (mm)
THVE 20/A-RC	507698-000	24	25 - 120	320
THVE 20/B-RC	190360-000		95 - 300	
THVE 20/C-RC	485361-000		240 - 630	
THVE 30/A-RC	454523-000	36	50 - 185	430
THVE 30/B-RC	308359-000		120 - 240	
THVE 30/C-RC	651264-000		240 - 630	

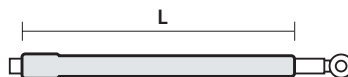

For cables CPR RG26H1M16 12/20 kV (U_{max} 24 kV)

Product Item	Nominal voltage U _{max} (kV)	∅ on insulation (mm)	∅ on external sheath (mm)	Conductor cross section (mm ²)	L (mm)
THVE 20/A-RC 507698-000	24	17	26	25	320
		17	27	35	
THVE 20/B-RC 190360-000	24	18	28	50	320
		19	29	70	
		20,6	30	95	
		22	32	120	
		23,7	34	150	
THVE 20/C-RC 485361-000	24	25	36	185	320
		27,8	39	240	
		30,8	43	300	
		33	46	400	
		37	49	500	
		40	51	630	

The heat shrink terminations for cables in accordance with CPR, type RG26H1M16 (Italian designation), are suitable for

- Cables with copper conductors
- Special thermoplastic sheath
- Red copper wire screen
- High modulus rubber insulation

For cables CPR RG26H1M16 18/30 kV (U_{max} 36 kV)

Product Item	Nominal voltage U _{max} (kV)	∅ on insulation (mm)	∅ on external sheath (mm)	Conductor cross section (mm ²)	L (mm)
THVE 30/B-RC 308359-000	36	25,6	32	35	430
		25	35	50	
		25	36	70	
		26	37	95	
		27	38	120	
		28,2	39	150	
		29,2	41	185	
THVE 30/C-RC 651264-000	36	31,5	43	240	430
		34,4	46	300	
		37	48	400	
THVE 30/D-RC 700320-000	36	41	52	500	430
		45	55	630	

★ ADVANTAGES

- Immediately energizable
- Quick in installation
- Simple and reliable they do not require a special skilling
- Optimal distribution of the electric field
- Can be installed in all environmental conditions
- No shelf life

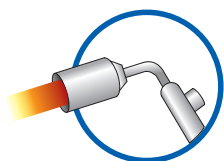

HEAT-SHRINK TERMINATIONS FOR **INDOOR USE** FOR **ARMOURED CABLES**

Terminations for **SINGLE CORE** extruded cables up to **36 kV**.



Electrical performance:

CEI 20-24 • CEI 20-62/1 • HD 629-1

Kit composition:

Three single core terminations

RANGES OF APPLICATION

For single core cables type:

Extruded cable, wire or tape screened, aluminium wire armoured

Extruded cable, wire or tape screened, aluminium tape armoured

For cables armoured with wires or aluminium tape

For Umax cables

7,2 kV

Product	Item	Voltage Umax (kV)	Conductor cross section (mm ²)	L (mm)
THVI 6/O-ARM	THVI6/O-ARM	7,2	25 - 70	460
THVI 6/A-ARM	THVI6/A-ARM		95 - 120	
THVI 6/B-ARM	THVI6/B-ARM		150 - 400	
THVI 6/C-ARM	THVI6/C-ARM		500 - 630	

For Umax cables from **12 to 24 kV**

Product	Item	Umax 12 kV sect. (mm ²)	Umax 17,5 kV sect. (mm ²)	Thickness FULL Umax 24 kV sect. (mm ²)	Thickness LOW Umax 24 kV sect. (mm ²)	L (mm)
THVI 20/A-ARM	507698-002	25 - 95	25 - 50	25 - 50	25 - 120	600
THVI 20/B-ARM	190360-002	120 - 300	70 - 300	70 - 240	95 - 300	
THVI 20/C-ARM	485361-002	400 - 800	400 - 800	240 - 630	240 - 630	

For Umax cables

36 kV

Product	Item	Voltage Umax (kV)	Conductor cross section (mm ²)	L (mm)
THVI 30/A-ARM	THVI30/A-ARM	36	35 - 95	730
THVI 30/B-ARM	THVI30/B-ARM		120 - 185	
THVI 30/C-ARM	THVI30/C-ARM		240 - 500	

★ ADVANTAGES

- Immediately energizable
- Quick in installation
- Simple and reliable they do not require a special skilling
- Optimal distribution of the electric field
- Can be installed in all environmental conditions
- No shelf life

HEAT-SHRINK TERMINATIONS FOR OUTDOOR USE FOR NON ARMoured CABLES

Terminations for **SINGLE CORE** extruded cables up to **36 kV**.

For cables (A)RG16HIR12 and (A)RG7HIR insulation thickness **FULL**

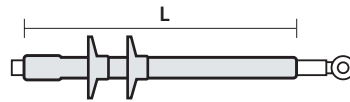

Product	Item	Voltage Umax (kV)	Conductor cross section (mm ²)	L (mm)
THVE 6/120-E	THVE6/120-E	7,2	25 - 120	340
THVE 6/400-E	164000-000		150 - 400	
THVE 6/630-E	606630-TEC		500 - 630	
THVE 15/50-E	120036-TEC	12	25 - 95	450
THVE 15/300-E	206772-000		120 - 300	
THVE 15/800-E	125336-TEC		400 - 630	
THVE 15/50-E	120036-TEC	17,5	25 - 50	450
THVE 15/300-E	206772-000		70 - 300	
THVE 15/800-E	125336-TEC		400 - 800	
THVE 20/25-E	231047-TEC	24	25 - 50	520
THVE 20/240-E	255098-TEC		70 - 240	
THVE 20/630-E	792760-000		240 - 630	
THVE 30/95-E	900926-000	36	35 - 95	720
THVE 30/185-E	120057-TEC		120 - 185	
THVE 30/500-E	372083-000		240 - 500	

For shielded aluminium tube cables, add terminal abbreviation **H5**.

For cables RG7H1M1 Afumex insulation thickness **LOW**

Product	Item	Voltage Umax (kV)	Conductor cross section (mm ²)	L (mm)
THVE 20/25-E	231047-TEC	24	25 - 120	520
THVE 20/240-E	255098-TEC		95 - 300	
THVE 20/630-E	792760-000		240 - 630	
THVE 30/95-E	900926-000	36	50 - 185	720
THVE 30/185-E	120057-TEC		120 - 240	
THVE 30/500-E	372083-000		240 - 630	

★ ADVANTAGES

- Immediately energizable
- Quick in installation
- Simple and reliable they do not require a special skilling
- Optimal distribution of the electric field
- Can be installed in all environmental conditions
- No shelf life

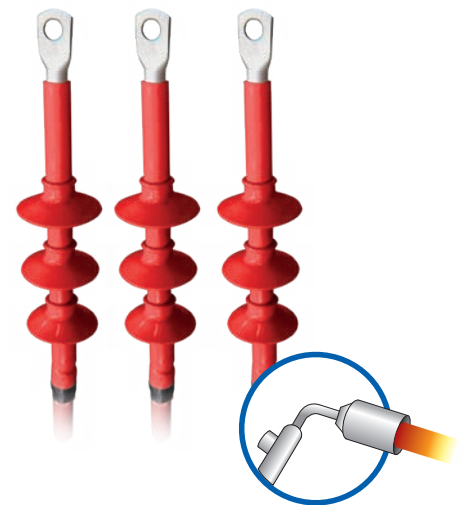

Electrical performance:

CEI 20-24 • CEI 20-62/1 • HD 629-1

Kit composition:

Three single core terminations

RANGES OF APPLICATION

For single core cables type:

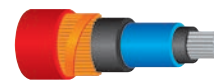

Extruded cable, copper wire screen



Extruded cable, copper tape screen



Extruded cable, aluminium tube screen

TEMPERATURES

105°C
Working temperature

140°C
Max overload temperature

300°C
Short circuit temperature

For complementary accessories see page 157

The heat shrink terminations for cables in accordance with CPR, type RG26H1M16 (Italian designation), are suitable for

- Cables with copper conductors
- Special thermoplastic sheath
- Red copper wire screen
- High modulus rubber insulation

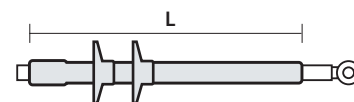

For cables CPR RG26H1M16 12/20 kV (U_{max} 24 kV)

Product Item	Voltage U _{max} (kV)	∅ on insulation (mm)	∅ on external sheath (mm)	Conductor cross section (mm ²)	L (mm)
THVE 20/25-E 231047-TEC	24	17	26	25	520
		17	27	35	
THVE 20/240-E 255098-TEC	24	18	28	50	520
		19	29	70	
		20,6	30	95	
		22	32	120	
		23,7	34	150	
THVE 20/630-E 792760-000	24	25	36	185	520
		27,8	39	240	
		30,8	43	300	
		33	46	400	
		37	49	500	
		40	51	630	

For cables CPR RG26H1M16 18/30 kV (U_{max} 36 kV)

Product Item	Voltage U _{max} (kV)	∅ on insulation (mm)	∅ on external sheath (mm)	Conductor cross section (mm ²)	L (mm)
THVE 30/185-E 120057-TEC	36	25,6	32	35	720
		25	35	50	
		25	36	70	
		26	37	95	
		27	38	120	
		28,2	39	150	
THVE 30/500-E 372083-000	36	29,2	41	185	720
		31,5	43	240	
		34,4	46	300	
THVE 30/1000-E 407002-000	36	37	48	400	720
		41	52	500	
		45	55	630	

HEAT-SHRINK TERMINATIONS FOR OUTDOOR USE FOR ARMoured CABLES

Terminations for **SINGLE CORE** extruded cables up to **36 kV**.

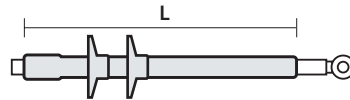

For cables armoured with wires or aluminium tape

For U_{max} cables
7,2 kV

Product	Item	Voltage U _{max} (kV)	Conductor cross section (mm ²)	L (mm)
THVO 6/70-ARM	THVO6/70-ARM	7,2	25 - 70	600
THVO 6/120-ARM	THVO6/120-ARM		95 - 120	
THVO 6/400-ARM	THVO6/400-ARM		150 - 400	
THVO 6/630-ARM	THVO6/630-ARM		500 - 630	

For U_{max} cables
from **12 to 24 kV**

Product	Item	U _{max} 12 kV	U _{max} 17,5 kV	Thickness FULL	Thickness LOW	L (mm)
		sect. (mm ²)	sect. (mm ²)	U _{max} 24 kV sect. (mm ²)	U _{max} 24 kV sect. (mm ²)	
THVO 20/25-ARM	231049-TEC	25 - 95	25 - 50	25 - 50	25 - 120	800
THVO 20/240-ARM	255100-TEC	120 - 300	70 - 300	70 - 240	95 - 300	
THVO 20/630-ARM	792762-000	400 - 800	400 - 800	240 - 630	240 - 630	

For U_{max} cables
36 kV

Product	Item	Voltage U _{max} (kV)	Conductor cross section (mm ²)	L (mm)
THVO 30/95-ARM	THVO30/95-ARM	36	35 - 95	1020
THVO 30/185-ARM	THVO30/185-ARM		120 - 185	
THVO 30/500-ARM	THVO30/500-ARM		240 - 500	

★ ADVANTAGES

- Immediately energizable
- Quick in installation
- Simple and reliable they do not require a special skilling
- Optimal distribution of the electric field
- Can be installed in all environmental conditions
- No shelf life

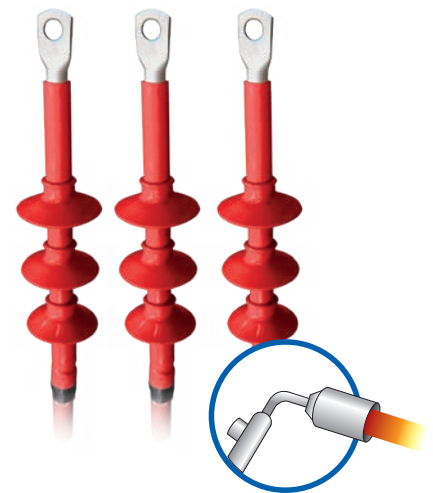

Electrical performance:

CEI 20-24 • CEI 20-62/1 • HD 629-1

Kit composition:

Three single core terminations

Extruded cable, wire or tape
screened, aluminium wire
armoured

Extruded cable, wire or tape
screened, aluminium tape
armoured

For complementary accessories see page 157

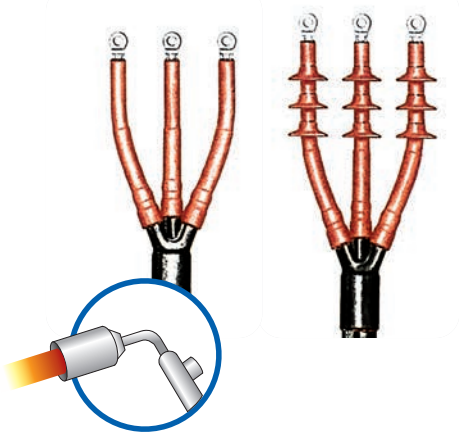

Electrical performance:

CEI 20-24 • CEI 20-62/1 • HD 629-1

RANGES OF APPLICATION

For three-core cable cables type:



Three-core cable extruded, unarmoured



Three-core cable extruded, wire or tape armoured

★ **ADVANTAGES**

- Immediately energizable
- Quick in installation
- Simple and reliable they do not require a special skilling
- Optimal distribution of the electric field
- Can be installed in all environmental conditions
- No shelf life

THREE-CORE HEAT-SHRINK TERMINATIONS FOR INDOOR/OUTDOOR USE

Terminations for armoured and non armoured extruded cables up to **36 kV**.

For INDOOR USE

For NON ARMoured cables

Product	Item	Voltage U _{max} (kV)	Conductor cross section (mm ²)
THVI 6/0-3	THVI6/0-3	7,2	25 - 35
THVI 6/A-3	THVI6/A-3		50 - 120
THVI 6/B-3	THVI6/B-3		150 - 400
THVI 6/C-3	THVI6/C-3		500

Product	Item	U _{max} 12 kV sect. (mm ²)	U _{max} 17,5 kV sect. (mm ²)	U _{max} 24 kV sect. (mm ²)
THVI 20/A-3	507698-003	25 - 95	25 - 50	25 - 50
THVI 20/B-3	190360-003	120 - 300	70 - 300	70 - 240
THVI 20/C-3	485361-003	400 - 500	400	300

Product	Item	Voltage U _{max} (kV)	Conductor cross section (mm ²)
THVI 30/A-3	507702-TTEC	36	35 - 95
THVI 30/B-3	507701-002		120 - 185
THVI 30/C-3	THVI30/C-3		240

For ARMoured cables

Product	Item	Voltage U _{max} (kV)	Conductor cross section (mm ²)
THVI 6/0-3-ARM	THVI6/0-3-ARM	7,2	25 - 35
THVI 6/A-3-ARM	THVI6/A-3-ARM		50 - 120
THVI 6/B-3-ARM	THVI6/B-3-ARM		150 - 400
THVI 6/C-3-ARM	THVI6/C-3-ARM		500

Product	Item	U _{max} 12 kV sect. (mm ²)	U _{max} 17,5 kV sect. (mm ²)	U _{max} 24 kV sect. (mm ²)
THVI 20/A-3-ARM	507698-004	25 - 95	25 - 50	25 - 50
THVI 20/B-3-ARM	190360-004	120 - 300	70 - 300	70 - 240
THVI 20/C-3-ARM	485361-004	400 - 500	400	300

Product	Item	Voltage U _{max} (kV)	Conductor cross section (mm ²)
THVI 30/A-3-ARM	THVI30/A-3-ARM	36	35 - 95
THVI 30/B-3-ARM	507701-001		120 - 185
THVI 30/C-3-ARM	THVI30/C-3-ARM		240

For OUTDOOR USE

For NON ARMoured
cables

Product	Item	Voltage U _{max} (kV)	Conductor cross section (mm ²)
THVO 6/35-3	THVO6/35-3	7,2	25 - 35
THVO 6/120-3	THVO6/120-3		50 - 120
THVO 6/400-3	THVO6/400-3		150 - 400
THVO 6/500-3	THVO6/500-3		500

Product	Item	U _{max} 12 kV sect. (mm ²)	U _{max} 17,5 kV sect. (mm ²)	U _{max} 24 kV sect. (mm ²)
THVO 20/25-3	231050-TEC	25 - 95	25 - 50	25 - 50
THVO 20/240-3	255101-TEC	120 - 300	70 - 300	70 - 240
THVO 20/630-3	792763-000	400 - 500	400	300

Product	Item	Voltage U _{max} (kV)	Conductor cross section (mm ²)
THVO 30/95-3	231054-TEC	36	35 - 95
THVO 30/185-3	THVO30/185-3		120 - 185
THVO 30/240-3	THVO30/240-3		240

For ARMoured
cables

Product	Item	Voltage U _{max} (kV)	Conductor cross section (mm ²)
THVO 6/35-3-ARM	THVO6/35-3-ARM	7,2	25 - 35
THVO 6/120-3-ARM	THVO6/120-3-ARM		50 - 120
THVO 6/400-3-ARM	THVO6/400-3-ARM		150 - 400
THVO 6/500-3-ARM	THVO6/500-3-ARM		500

Product	Item	U _{max} 12 kV sect. (mm ²)	U _{max} 17,5 kV sect. (mm ²)	U _{max} 24 kV sect. (mm ²)
THVO 20/25-3-ARM	231051-TEC	25 - 95	25 - 50	25 - 50
THVO 20/240-3-ARM	255102-TEC	120 - 300	70 - 300	70 - 240
THVO 20/630-3-ARM	792764-000	400 - 500	400	300

Product	Item	Voltage U _{max} (kV)	Conductor cross section (mm ²)
THVO 30/95-3-ARM	THVO30/95-3-ARM	36	35 - 95
THVO 30/185-3-ARM	THVO30/185-3-ARM		120 - 185
THVO 30/240-3-ARM	THVO30/240-3-ARM		240

Electrical performance:

CEI 20-24 • CEI 20-62/1 • HD629-1

ENEL tables: DJ 4456/3 • DJ 4476/2
ENEL certification: DJ 4853 • DJ 4854
 Single core cable AL tube screen



ENEL tables: DJ 4456
ENEL certification: DJ 4853 • DJ 4854
 Single core cable extruded wires screen



ENEL CERTIFIED HEAT-SHRINK TERMINATIONS

For single core type indoor and outdoor use.

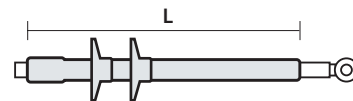

ELICORD TYPE EXTRUDED CABLE (ARG7H5EXY 12/20 KV)

Product Item	Type	ENEL serial number	Conductor cross section (mm ²)	L (mm)
THVE 20/150-I/U 364179-000	With 2 INTERNAL sheaths	273047	35 ÷ 150	365
IXSU-F-5131-IT02 364180-000	Single INTERNAL tube	273047	35 ÷ 150	365
THVE 20/150-E/U 123021-000	With 2 EXTERNAL sheaths	273066	35 ÷ 150	450
OXSU-F-5131-IT02 123020-000	Single EXTERNAL tube	273066	35 ÷ 150	450

EXTRUDED CABLE FOR UNDERGROUND INSTALLATION ([A] RG7H1R 12/20 KV)

Product Item	Type	ENEL serial number	Conductor cross section (mm ²)	L (mm)
IXSU-F-5121-IT01 200315-000	Single INTERNAL tube	273045	25	360
THVE 20/185-I/U 618430-000	With 2 INTERNAL sheaths	273046	50 - 185	360
IXSU-F-5131-IT01 618429-000	Single INTERNAL tube	273046	50 - 185	360
THVE 20/240-I/U 521413-000	With 2 INTERNAL sheaths	273048	240	360
IXSU-F-5151-IT01 897524-000	Single INTERNAL tube	273049	400 - 630	360
THVE 20/185-E/U 365891-000	With 2 EXTERNAL sheaths	273065	50 - 185	450
OXSU-F-5131-IT01 365890-000	Single EXTERNAL tube	273065	50 - 185	450

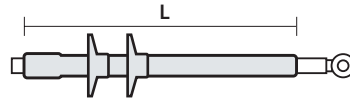

INSULATED CABLE MADE OF IMPREGNATED PAPER ([A] RC1HLRX 12/20 KV)

Product Item	Type	ENEL serial number	Conductor cross section (mm ²)	L (mm)
THVP 20/240-I/U 252214-000	INTERNAL	273042	50 - 240	370
THVP 20/240-E/U-N1 145110-000	EXTERNAL	273083	50 - 240	600

ENEL tables: DJ 4453 • DJ 4473

ENEL certification: DJ 4854 • DJ 4851
Single core cable paper lead sheathed



EXTRUDED CABLE FOR UNDERGROUND INSTALLATION WITH ALUMINIUM TUBE SHIELD (ARE4H5EX 12/20 KV)

Product Item	Type	ENEL serial number	Conductor cross section (mm ²)	∅ (mm) insulation		L (mm)
				min	max	
IXSU-F-5131-IT04 124400-TEC	INTERNAL	273040	70 - 185	19	27	350
OXSU-F-5131-IT03 124500-TEC	EXTERNAL	273064	70 - 185	19	27	450

ENEL tables: DJ4456/6 • DJ4476/7

ENEL certification: DJ4853
Single core cable AL tube



★ ADVANTAGES

- Immediately energizable
- Quick in installation
- Simple and reliable they do not require a special skilling
- Optimal distribution of the electric field
- Can be installed in all environmental conditions
- No shelf life



VOLTAGE DISTRIBUTION (PERCENT)
HEAT-SHRINKABLE JOINT

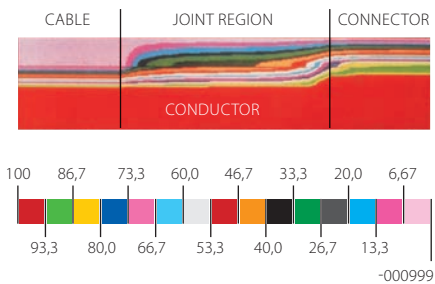

HEAT-SHRINK JOINTS

The preparation of cables and the installation techniques for medium voltage joints are identical to those for terminations. Even cable made with paper impregnated with non-migrant oil up to 36 kV uses the same basic design. In this way, the heat-shrink system sets new standards regarding the effectiveness, reliability and simplicity of cable installation. The performance and ease of installation of heat-shrink materials are not affected by stocking, even if long and in adverse environmental conditions. A low number of "kits" per cable type covers the entire range of sections, allowing use with any type of connector, regardless of the type of conductor (round or sectoral) and different shields.

ELECTRICAL FIELD DISTRIBUTION

When the cable shield is cut, the electrical field is controlled by a material that has already been experimented in terminations: the electrical gradient control tube. This tube is made of non-linear impedance insulating material that is able to control the electrical field both at the end of the cable shield and on the metal connector. As with the terminations, thanks to the heat-shrink components, the range of joints includes practically all the configurations of the existing cables, as well as the joints mixed between different types of cable. The kit references that appear on the selection tables are those that are most used by national installers for cable applications up to 36 kV. In the described cases, please contact Raytech regardless of the type of cable.

HOW TO IDENTIFY AND ORDER COMPLEMENTARY ACCESSORIES

Accessory	Abbreviation to add to the product code	Example
Copper connectors	-C + Conductor cross section	GHVE 20/185-C95
Aluminium connectors	-CA + Conductor cross section	GHVE 20/185-CA95
Shear bolt connectors	-CPR + conductor cross section	GHVE 20/185-CPR95

INSTALLATION SEQUENCE

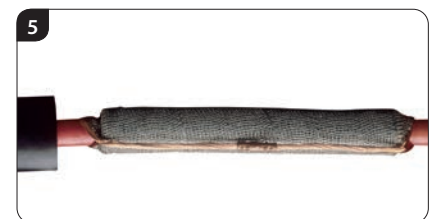
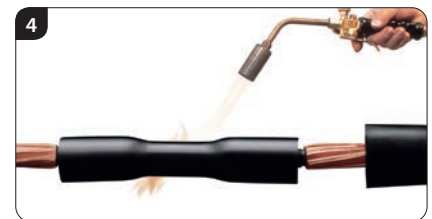
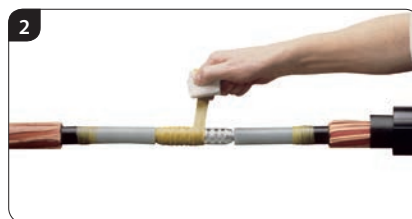

SINGLE CORE HEAT-SHRINK JOINTS

For extruded and impregnated paper insulated cables.

High reliability and superior electrical, mechanical and sealing properties make these joints the ideal solution for all types of cables and installation.

FOR EXTRUDED INSULATION CABLES WITH COPPER WIRE SHIELD ([A]RG7H1R[X], [A]RE4H1E[X], [A]RG7H1M1[X])

Product	Item	U _{max} (kV)	Conductor cross section from (mm ²) to (mm ²)		L max (mm)	D max (mm)
GHVE 15/50-1	153003-000	7,2 - 17,5	25	50	700	75
GHVE 15/300-1	442803-000	7,2 - 17,5	70	300	700	80
GHVE 15/630-1	357174-000	7,2 - 17,5	400	630	1000	100
GHVE 20/240-1	623051-000	24	25	240	700	80
GHVE 20/630-1	GHVE20/630-1	24	240	630	1000	100
GHVE 30/240-1	GHVE30/240-1	36	35	240	1000	90
GHVE 30/500-1	GHVE30/500-1	36	300	500	1000	100

FOR EXTRUDED INSULATION CABLES WITH ALUMINIUM TUBE SHIELD ([A]RG7H1R[X], [A]RE4H1E[X], [A]RG7H1M1[X])

Product	Item	U _{max} (kV)	Conductor cross section from (mm ²) to (mm ²)		L max (mm)	D max (mm)
GHVE 15/50-1-H5	GHVE15/50-1-H5	17,5	25	50	700	75
GHVE 15/300-1-H5	GHVE15/300-1-H5	17,5	50	300	700	80
GHVE 15/630-1-H5	GHVE15/630-1-H5	17,5	400	630	1000	100
GHVE 20/240-1-H5	GHVE20/240-1-H5	24	25	240	700	80
GHVE 20/630-1-H5	GHVE20/630-1-H5	24	240	630	1000	100
GHVE 30/240-1-H5	GHVE30/240-1-H5	36	35	240	1000	90
GHVE 30/500-1-H5	GHVE30/500-1-H5	36	300	500	1000	100

FOR SINGLE CORE EXTRUDED INSULATION CABLES ARMoured WITH ALUMINIUM WIRES ([A]RG7H1RFR[X], [A]RE4H1EFE[X])

Product	Item	U _{max} (kV)	Conductor cross section from (mm ²) to (mm ²)		L max (mm)	D max (mm)
GHVE 20/240-1-ARM	623052-000	24	25	240	1700	80
GHVE 20/630-1-ARM	GHVE20/630-1-ARM	24	240	630	1700	100
GHVE 30/240-1-ARM	GHVE30/240-1-ARM	36	35	240	1850	100
GHVE 30/500-1-ARM	GHVE30/500-1-ARM	36	300	500	1850	110

FOR INSULATED CABLES MADE OF PAPER IMPREGNATED WITH MIXTURE ([A]RC1HLR[X])

Product	Item	U _{max} (kV)	Conductor cross section from (mm ²) to (mm ²)		L max (mm)	D max (mm)
GHVP 20/70-1	190901-000	24	35	70	1000	75
GHVP 20/240-1	GHVP20/240-1	24	50	240	1000	75
GHVP 20/400-1	861101-000	24	300	400	1000	80

Supplies do not include connectors which must be requested separately.

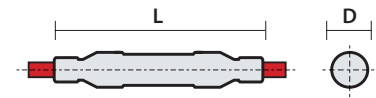
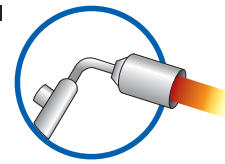

Electrical performance:

CEI 20-24 • HD 629-1 • HD 629-2



For complementary accessories see page 168

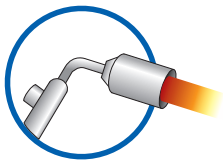

Electrical performance:
CEI 20-24 • HD 629-1 • HD 629-2

Accessories for cables in accordance with CPR, type RG26H1M16 (Italian designation), are suitable for

- Cables with copper conductors
- Special thermoplastic sheath
- Red copper wire screen
- High modulus rubber insulation

SINGLE CORE HEAT-SHRINK JOINTS

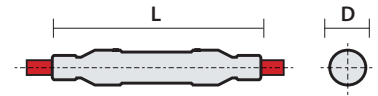

For cables CPR RG26H1M16 12/20 kV (U_{max} 24 kV)

Product Item	U _{max} (kV)	∅ on insulation (mm)	∅ on external sheath (mm)	Conductor cross section (mm ²)	L max (mm)	D max (mm)
GHVE 20/240-1 623051-000	24	17	26	25	700	80
		17	27	35	700	80
		18	28	50	700	80
		19	29	70	700	80
		20,6	30	95	700	80
		22	32	120	700	80
		23,7	34	150	700	80
		25	36	185	700	80
GHVE 20/630-1 GHVE20/630-1	24	27,8	39	240	1000	100
		30,8	43	300	1000	100
		33	46	400	1000	100
		37	49	500	1000	100

For cables CPR RG26H1M16 18/30 kV (U_{max} 36 kV)

Product Item	U _{max} (kV)	∅ on insulation (mm)	∅ on external sheath (mm)	Conductor cross section (mm ²)	L max (mm)	D max (mm)
GHVE 30/240-1 GHVE30/240-1	36	25,6	32	35	1000	90
		25	35	50	1000	90
		25	36	70	1000	90
		26	37	95	1000	90
		27	38	120	1000	90
		28,2	39	150	1000	90
		29,2	41	185	1000	90
		31,5	43	240	1000	90
GHVE 30/500-1 GHVE30/500-1	36	34,4	46	300	1000	100
		37	48	400	1000	100
		41	52	500	1000	100

TEMPERATURES

105°C
Working temperature

140°C
Max overload temperature

300°C
Short circuit temperature

★ ADVANTAGES

- Immediately energizable
- Quick in installation
- Simple and reliable they do not require a special skilling
- Optimal distribution of the electric field
- Can be installed in all environmental conditions
- No shelf life

THREE CORE HEAT-SHRINK JOINTS

For extruded insulation cables and insulated cables.

High reliability and superior electrical, mechanical and sealing properties make these joints the ideal solution for all types of cables and installation.

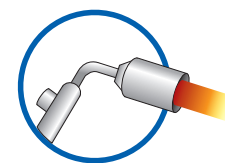
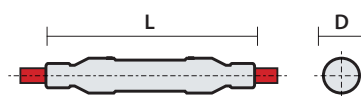

Electrical performance:

CEI 20-24 • CEI 20-62/2 • HD 629-1

FOR EXTRUDED INSULATION CABLES ([A]RG7H1OR, [A]RE4H1OR)

Product	Item	U _{max} (kV)	Conductor cross section from (mm ²) to (mm ²)		L max (mm)	D max (mm)
GHVE 15/50-3	545116-000	7,2 - 17,5	25	50	1500	105
GHVE 15/300-3	251291-000	7,2 - 17,5	70	300	1500	110
GHVE 15/630-3	GHVE15/630-3	7,2 - 17,5	400	630	1600	130
GHVE 20/240-3	708732-000	24	25	240	1500	110
GHVE 20/630-3	GHVE20/630-3	24	300	630	1600	140
GHVE 30/240-3	GHVE30/240-3	36	50	240	1800	120
GHVE 30/300-3	GHVE30/300-3	36	300		1900	150

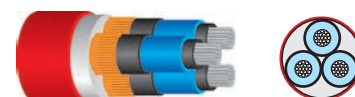

FOR INSULATED ARMoured CABLES WITH GALVANIC CONTINUITY OF ARMOUR

Product	Item	U _{max} (kV)	Conductor cross section from (mm ²) to (mm ²)		L max (mm)	D max (mm)
GHVE 15/50-ARM	155000-001	7,2 - 17,5	25	50	1500	75
GHVE 15/300-ARM	153000-001	7,2 - 17,5	70	300	1500	110
GHVE 15/630-ARM	GHVE15/630-ARM	7,2 - 17,5	400	630	1600	130
GHVE 20/240-ARM	202400-001	24	25	240	1500	110
GHVE 20/630-ARM	GHVE20/630-ARM	24	300	630	1600	140
GHVE 30/240-ARM	GHVE30/240-ARM	36	50	240	1800	120
GHVE 30/300-ARM	GHVE30/300-ARM	36	300		1900	150



FOR INSULATED CABLES MADE OF IMPREGNATED PAPER ([A]RC1HLOR LEAD SHEATH OVER EACHCORE)

Product	Item	U _{max} (kV)	Conductor cross section from (mm ²) to (mm ²)		L max (mm)	D max (mm)
GHVP 20/70-3	056242-000	24	35	70	1600	130
GHVP 20/240-3	843918-000	24	95	240	1600	140
GHVP 20/400-3	741685-000	24	300	400	1600	150

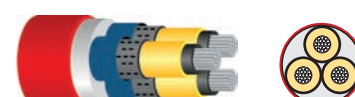

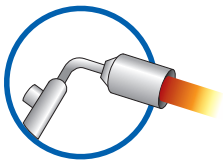

Electrical performance:

CEI 20-24 • CEI 20-62/2
HD 629-1 • HD 629-2

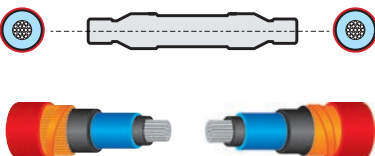
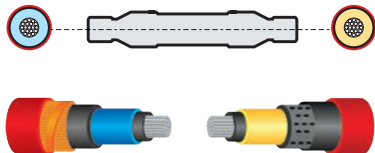
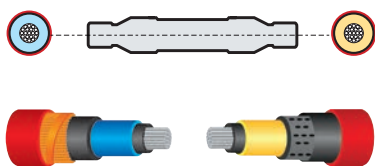

TRANSITION JOINTS BETWEEN SINGLE CORE CABLES

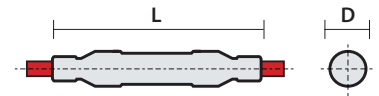

BETWEEN SINGLE CORE PAPER INSULATED CABLE AND EXTRUDED CABLE (RESPECTIVELY [A]RG7H1R[X] AND [A]RC1HLRX)

Product Item	U _{max} (kV)	Conductor cross section (mm ²)		ENEL serial number
		paper cable	extruded cable	
GHVE 20/25-1-T 202500-000	24		25	-
GHVE 20/240-1-T GHVE20/240-1-T	24	50 - 240	35 - 185	271074
GHVE 20/400-1-T 250499-000	24		240 - 400	-

BETWEEN SINGLE CORE PAPER INSULATED CABLE AND EXTRUDED CABLE WITH ALUMINIUM SHEET SCREEN (RESPECTIVELY [A]RC1HLRX AND ARG7H5EXY)

Product Item	U _{max} (kV)	Conductor cross section (mm ²)		ENEL serial number
		paper cable	extruded cable	
GHVE 20/240-1-TE GHVE20/240-1-TE	24	50 - 240	35 - 150	270118

BETWEEN SINGLE CORE EXTRUDED CABLE WITH WIRE SCREEN AND EXTRUDED CABLE WITH ALUMINIUM FOIL SCREEN (RESPECTIVELY [ARG7H1R[X] OR [A]RG7H1M1 AND ARG7H5EXY)

Product Item	U _{max} (kV)	Conductor cross section		L max (mm)	D max (mm)
		from (mm ²)	to (mm ²)		
GHVE 20/240-1X-TE GHVE20/240-1X-TE	24	25	240	1000	75

TRANSITION JOINTS BETWEEN MULTI CORE CABLES

The three core transition joints kits are composed of one three core joint and do not contain the connectors.

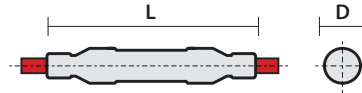

BETWEEN 3-CORE PAPER INSULATED CABLE AND 3 SINGLE CORE EXTRUDED CABLES (RESPECTIVELY [A]RC1HLOR AND [A]RG7H1R[X])

Product Item	U _{max} (kV)	Conductor cross section (mm ²)	
		paper cable	extruded cable
GHVT 20/25-1X-3H 202020-000	24	25	25
GHVT 20/240-1X-3H 202019-000	24	50 - 240	35 - 185
GHVT 20/400-1X-3H 202021-000	24	300 - 400	240 - 400

BETWEEN 3-CORE EXTRUDED CABLE AND 3 SINGLE CORE PAPER INSULATED CABLES (RESPECTIVELY [A]RG7H10R AND [A]RC1HLRX)

Product Item	U _{max} (kV)	Conductor cross section	
		from (mm ²)	to (mm ²)
GHVT 20/70-3X-1H on request 1	24	25	70
GHVT 20/240-3X-1H on request 2	24	95	240
GHVT 20/400-3X-1H on request 3	24	300	400

SINGLE CORE PLASTIC OR PAPER INSULATED CABLE JOINT WITH SCREEN INTERRUPTION

Single and three core joints are available, both on extruded cable and on impregnated paper insulated cable, also belted and for transition joint, which allow galvanic separation between the screens when the spliced cables are connected to two different earth networks.

Product Item	Type of cable	U _{max} (kV)	Conductor cross section		L max (mm)	D max (mm)
			from (mm ²)	to (mm ²)		
GHVP 20/240-1-IS 159852-INT	(A)RC4HLR(X)	24	50	240	1000	75
GHVE 20/240-1-IS 20GHIS-TEC	(A)GR7H1R(X)	24	50	240	1000	75
GHVE 20/150-1-IS 080799-TEC	ARG7H5EXY	24	35	150	1000	75

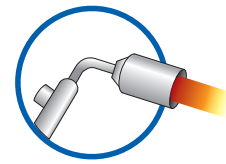

Electrical performance:

CEI 20-24 • CEI 20-62/2
HD 629-1 • HD 629-2

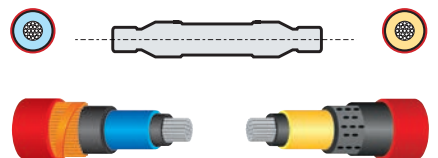
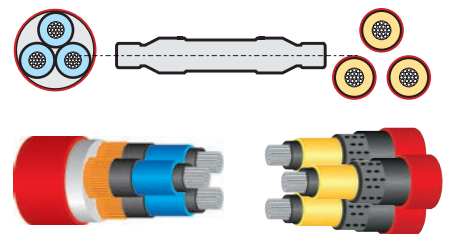
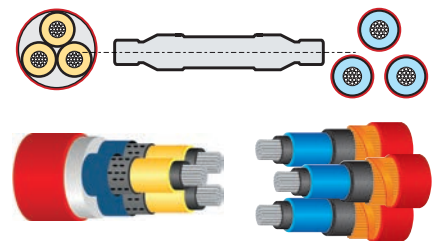

For complementary accessories see page 168

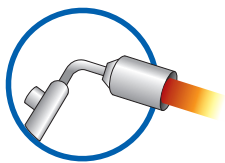

Electrical performance:

CEI 20-24 • CEI 20-62/2
HD 629-1 • HD 629-2

ENEL tables: DJ 4376
ENEL certification: DJ 4853 • DJ 4854

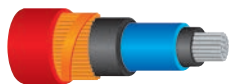

ENEL tables: DJ 4376
ENEL certification: DJ 4853 • DJ 4854



ENEL tables: DJ 4373
ENEL certification: DJ 4851 • DJ 4854

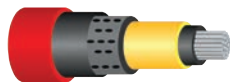

ENEL CERTIFIED HEAT-SHRINK JOINTS

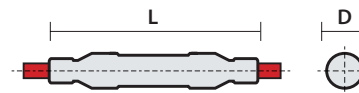

FOR EXTRUDED INSULATION CABLES ([A]RG7H1RX 12/20 KV COPPER WIRE SHIELD - EXTERNAL PVC SHEATH)

Product Item	U _{max} (kV)	Conductor cross section from (mm ²) to (mm ²)		L max (mm)	ENEL serial number
GHVE 20/185 - 1/U 512605-000	24	50	185	700	271071

FOR WIRE CARRYING OVERHEAD CABLES (ARG7H5EXY 12/20 KV ALUMINIUM TUBE SHIELD - EXTERNAL PE SHEATH)

Product Item	U _{max} (kV)	Conductor cross section from (mm ²) to (mm ²)		L max (mm)	ENEL serial number
GHVE 20/150 - 1/U 478596-000	24	35	150	700	271072

FOR INSULATED CABLES WITH IMPREGNATED PAPER (RC4HLRX WITH COPPER CONDUCTORS from 50 to 150 mm² and ARC4HLRX WITH ALUMINIUM CONDUCTORS from 95 to 240 mm²)

Product Item	U _{max} (kV)	Conductor cross section from (mm ²) to (mm ²)		L max (mm)	ENEL serial number
GHVP 20/150 - 1/U 085563-000	17,5 e 24	50	150	1000	-
GHVP 20/240 - 1/U 573299-000	17,5 e 24	95	240	1000	271042

HEAT-SHRINK TERMINATIONS FOR HIGH VOLTAGE (UMAX 52 KV)

Kit contains a limited number of components with unlimited shelf life at normal storage conditions. Three basic kits cover all possible cable sections, with the advantage of keeping a reduced and effective stock. The lightness and limited volume of the kits facilitate their handling and transport. No special additional training is required. Simple installation for reliable results.

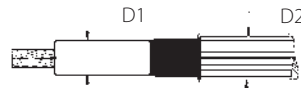

FOR INDOOR		Voltage U _{max} (kV)	Ø D1 insulation (mm)	Ø D2 max. external (mm)
Product	Item			
THVE 45/A-I	THVE45/A-I	52	30 - 45	60

FOR OUTDOOR		Voltage U _{max} (kV)	Ø D1 insulation (mm)	Ø D2 max. external (mm)
Product	Item			
THVE 45/A-E	THVE45/A-E	52	30 - 45	60

In the request, always indicate the cable section, its formation and the diameter on the insulation. Contact Raytech to choose the most suitable termination.

★ ADVANTAGES

- No shelf life under normal storage conditions
- Reduced and efficient stock
- Easy handling and transport
- No special additional training required
- Easy installation with safe results





**MEDIUM VOLTAGE
SEPARABLE
CONNECTORS
TAPES
SHEATHS**



SEPARABLE
CONNECTORS



Complies with standards

CEI 20-62/1 - Cenelec HD 629.1 S2

Kit composition:

Three single core terminations

SINGLE CORE SEPARABLE CONNECTORS WITH EXTERNAL CONE WITH CONTACT PLUG IN=250 A

Separable connectors for MV cables with extruded radial field for voltages up to **12/20 (24) kV**.

Single core separable connectors with contact plug In=250 A, elbow or straight for extruded cables. External coating in semi-conductive rubber protects personnel from electrocution. Each termination is factory tested before delivery with dielectric strength testing and measurements of partial discharges.

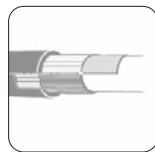

Contact Raytech for aluminium shield cables.

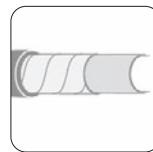

Kit available for tape screen. Add "A" to the end of the "Product code".

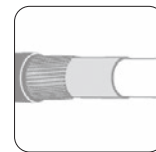

Connection kit for wire shield included.



Contact Raytech for information regarding other types of cable.

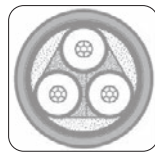

Kit available for three core cables. Order kit "TK." See table.

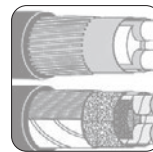

Contact Raytech for different armour grounding systems available.

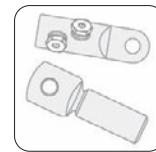

Different types of cable lugs available.

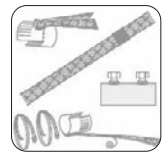

Contact Raytech about different shield grounding systems available.

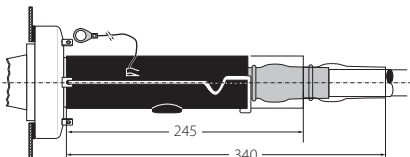
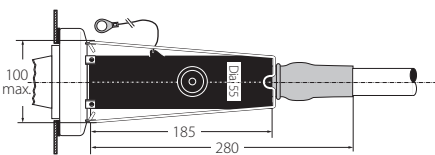
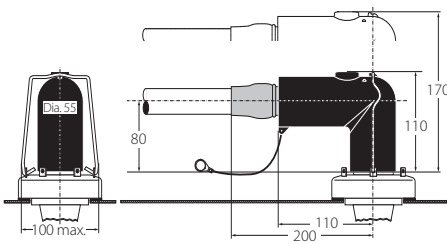

SEPARABLE INTERFACE "A" TERMINATION 24KV - 250 A

ELBOW		Voltage U _{max} (kV)	Cable insulation diameter range (mm)	Copper/aluminium mechanical conductor cross section range (mm ²)
Product	Item			
250 RTS-20/A-3	250RTS20/A-3	24	13,0 - 21,0	25 - 95
250 RTS-20/B-3	250RTS20/B-3		17,5 - 25,0	25 - 95
250 RTS-20/C-3	250RTS20/C-3		21,5 - 28,5	95 - 150

STRAIGHT		Voltage U _{max} (kV)	Cable insulation diameter range (mm)	Copper/aluminium mechanical conductor cross section range (mm ²)
Product	Item			
250 RTD-20/A-3	250RTD20/A-3	24	13,0 - 21,0	25 - 95
250 RTD-20/B-3	250RTD20/B-3		17,5 - 25,0	25 - 95
250 RTD-20/C-3	250RTD20/C-3		21,5 - 28,5	95 - 150

SEPARABLE CONNECTORS

SINGLE CORE SEPARABLE CONNECTORS WITH EXTERNAL CONE WITH CONTACT SCREW IN=630 A

Separable connectors for MV cables with extruded radial field, for voltages up to **19/33 (36) kV**.

Single core separable connectors with contact screw, for extruded cables. External coating in semi-conductive rubber protects personnel from electrocution. Each termination is factory tested before delivery with dielectric strength testing and measurements of partial discharges.

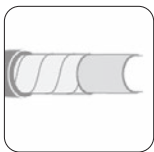

Kit available for tape screen. Add "A" to the end of the "Product code".

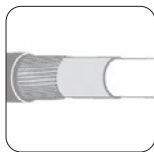

Connection kit for wire shield included.



Kit available for three core cables. Order kit "TK." See table.



For use in potentially explosive areas (12kV max.) Order: -/ATEX.

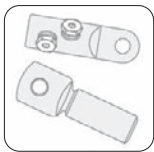

Different types of cable lugs available.

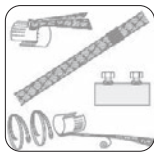

Contact Raytech for different shield grounding systems available.



Complies with standards

CEI 20-62/1 - Cenelec HD 629 .1 S2

Kit composition:

Three single core terminations

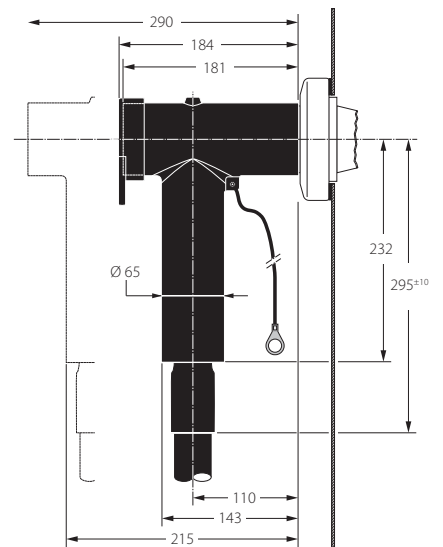
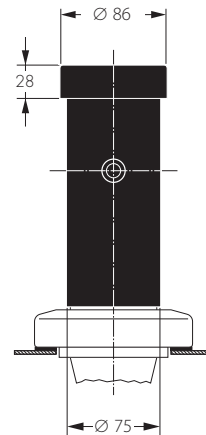

SEPARABLE TEE INTERFACE "C" TERMINATION 24/36KV - 630 A

Product	Item	Voltage Umax (kV)	Cable insulation Ø range (mm)	Copper/aluminium mechanical conductor cross section range (mm ²)
630 RTT-20/A-3-C95	630RTT20/A-3-C95	24	12,0 - 19,0	16 - 95
630 RTT-20/B-3-C95	630RTT20/B-3-C95		16,0 - 26,5	16 - 95
630 RTT-20/C-3-C240	630RTT20/C3-C240		19,0 - 32,6	95 - 240
630 RTT-20/D-3-C300	630RTT20/D3-C300		28,5 - 37,5	120 - 300
630 RTO-20/A-3-C400	630RTO20/A3-C400		28,5 - 37,5	185 - 400
630 RTO-20/B-3-C400	630RTO20/B3-C400		34,0 - 42,5	185 - 400
630 RTO-20/C-3-C630	630RTO20/C3-C630		39,0 - 48,5	400 - 630
630 RTO-20/D-3-C630	630RTO20/D3-C630		45,5 - 56,0	400 - 630
630 RTT-30/A-3-C95	630RTT30/A-3-C95	36	19,0 - 32,6	16 - 95
630 RTT-30/B-3-C240	630RTT30/B3-C240		22,0 - 34,6	95 - 240
630 RTT-30/C-3-C300	630RTT30/C3-C300		28,5 - 37,5	120 - 300
630 RTO-30/A-3-C400	630RTO30/A3-C400		28,5 - 37,5	185 - 400
630 RTO-30/B-3-C400	630RTO30/B3-C400		34,0 - 42,5	185 - 400
630 RTO-30/C-3-C630	630RTO30/C3-C630		39,0 - 48,5	400 - 630
630 RTO-30/D-3-C630	630RTO30/D3-C630		45,5 - 56,0	400 - 630



HEAT-SHRINK SHEATHS

Sheaths for insulating bars inside electrical cabinets or outdoors in primary or secondary cabinets.

Application

Primary (HV-MV) and secondary (MV-LV) electrical up to 36 kV today come in very compact sizes. Bars need to be insulated to prevent surface discharges and accidental short-circuits that are essentially caused by animal intrusion.

Heat-shrink sheaths for MV can be used on round and rectangular copper or aluminium bars. They are flexible and elastic, can be installed on previously bent bars without any risks of tearing or rippling.

Description

Sheaths utilise a special elastomer cross-linked by irradiation, with an exceptional insulating power and excellent seal over time, even in case of continuous use at high temperature. They do not contain halogens and therefore there is no risk of emission of toxic or corrosive substances in case of fire. They are resistant to solvents, UV radiation, exposure to weather, impact and tear, and therefore are fully suitable for use outdoors.

Installation

Sheaths for MV can be easily factory installed, when dealing with mass production, using an oven for heat-shrink. In situ, shrinking can be carried out with the aid of a torch or a hot air torch. Heat the sheath to over 120°C and it will shrink on the bar without risk of damage because the material is cross-linked and very resistant to high temperatures. The great elasticity of the sheaths allows, if necessary, for being of the bars during assembly of the electric cabinet with the sheath already installed.

DISTANCES ALLOWED IN BAR SYSTEMS

Phase/phase and phase/bus bars distances recommended with insulated bars with sheaths for MV. Studies and testing carried out on insulated bars have shown that it is possible to significantly reduce space with respect to those used in the case of air insulation. The minimum permitted space is defined by the absence of partial discharges at the time of testing in alternating current and by the seal upon impulse. The values shown can be applied to round or rectangular bars installed inside standard cabinets. Shapes with sharp edges or bar parallels of more than 5 m require larger spaces.

Round bus bars

Voltage Um (kV)

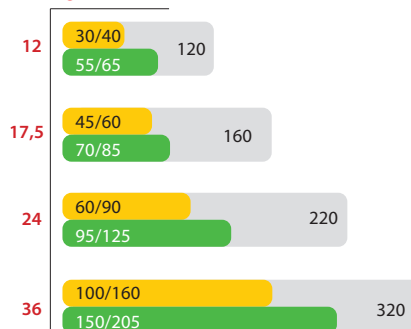

Rectangular bus bars

Voltage Um (kV)

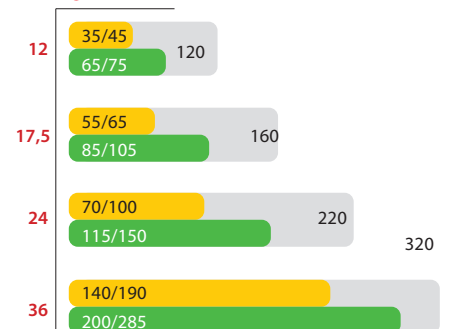

- Spacing in air according to IEC 71-2
phase / phase (mm)
phase / bus bars (mm)
- Insulation with BBT
- Insulation with BPM or HVBT with overlap of 2/3

For more information on different possible applications please contact Raytech.

BBT

Flexible, **heavy duty** heat-shrink sheath.

Suitable for reducing overhead distances in MV panels up to 36 kV.
Phase-to-phase distance reduced to approximately 1/3

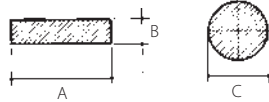

Product Item	Size of bus bars (mm)				Heat-shrink sheath (mm)			
	A+B		C		D	d	S ₁	S ₂
	from	to	from	to				
BBT 40/16-A/U BBT40/16-AU	28	45	18	32	40	16	1,6	3,8
BBT 65/25-A/U BBT65/25-AU	44	69	28	47	65	25	1,6	3,9
BBT 100/40-A/U BBT100/40-AU	69	102	44	72	100	40	1,6	4,0
BBT 150/60-A/U BBT150/60-AU	102	148	65	105	150	60	1,6	4,0

BPM

Flexible, **medium wall** heat-shrink sheath.

Suitable for optimising space in MV panels and for protection from discharges and accidental contact for systems up to 24 kV. Phase-to-phase distance reduced to approximately 1/2

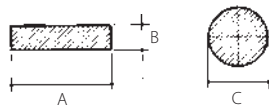

Product Item	Size of bus bars (mm)				Heat-shrink sheath (mm)			
	A+B		C		D	d	S ₁	S ₂
	from	to	from	to				
BPM 15/6-A/U BPM15/6-AU	12	20	6,5	12	15	6	1,1	2
BPM 30/12-A/U BPM30/12-AU	20	38	13,5	25	30	12	1,1	2,2
BPM 50/20-A/U BPM50/20-AU	36	65	22	43	50	20	1,1	2,4
BPM 75/30-A/U BPM75/30-AU	55	95	33	63	75	30	1,1	2,4
BPM 120/50-A/U BPM120/50-AU	90	165	55	105	120	50	1,3	2,8

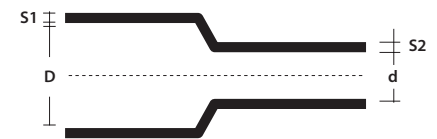

D = Ø minimum before shrinkage
d = Ø maximum after free shrinkage
S₁ = nominal thickness as supplied
S₂ = minimum nominal thickness after free shrinkage



D = Ø minimum before shrinkage
d = Ø maximum after free shrinkage
S₁ = nominal thickness as supplied
S₂ = minimum nominal thickness after free shrinkage

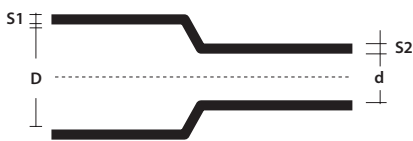
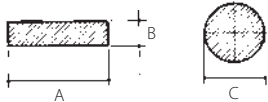

D = Ø minimum before shrinkage
 d = Ø maximum after free shrinkage
 S1 = nominal thickness as supplied
 S2 = minimum nominal thickness after free shrinkage

BPTM

Flexible, **medium wall** heat-shrink sheath.

Suitable for optimising space in MV panels and for protection from discharges and accidental contact for systems up to 24 kV. Phase-to-phase distance reduced to approximately 1/2

Product Item	Size of bus bars (mm)				Heat-shrink sheath (mm)			
	A+B		C		D	d	S ₁	S ₂
BPTM 15/6-A/U 5904284002	12	20	6,5	12	15	6	1,1	1,9
BPTM 30/12-A/U 723955-000	20	38	13,5	25	30	12	1,1	2,2
BPTM 50/20-A/U 2246244002	36	65	22	43	50	20	1,1	2,35
BPTM 75/30-A/U 6129164002	55	95	33	63	75	30	1,1	2,35
BPTM 100/40-A/U 178238-000	70	130	44	86	100	40	1,1	2,35
BPTM 120/50-A/U 412147-000	90	165	55	105	120	50	1,3	2,8
BPTM 175/70-A/U 920423-000	125	235	80	150	175	70	1,3	2,8
BPTM 205/110-A/U 499685-000	200	276	127	190	205	110	1,3	2,8

BBIT

Flexible, **heavy duty** heat-shrink sheath.

Suitable for reducing overhead distances in MV panels up to 36 kV. Phase-to-phase distance reduced to approximately 1/3

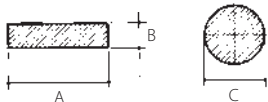

D = Ø minimum before shrinkage
 d = Ø maximum after free shrinkage
 S1 = nominal thickness as supplied
 S2 = minimum nominal thickness after free shrinkage

Product Item	Size of bus bars (mm)				Heat-shrink sheath (mm)			
	A+B		C		D	d	S ₁	S ₂
BBIT 25/10-A/U 5609274001	17	28	11	20	25	10	1,6	3,6
BBIT 40/16-A/U 560931-000	28	45	18	32	40	16	1,6	3,6
BBIT 65/25-A/U 5609364001	44	69	28	47	65	25	1,6	3,6
BBIT 100/40-A/U 560981-000	69	102	44	72	100	40	1,6	3,6
BBIT 150/60-A/U 560982-000	102	148	65	105	150	60	1,6	3,6
BBIT 175/80-A/U 426377-000	133	196	85	125	175	80	1,6	3,6

HEAT-SHRINK TAPES

HVBT heat-shrink tape coated in hot melt adhesive for MV.

Application

HVBT tape is part of the bar insulation product range. It is a heat-shrink tape coated with a hot melt adhesive on one side.

Installation

HVBT is installed wrapping it moderately taut on the bar with overlap equal to 2/3. When heated, it shrinks and adheres to the underlying layer. At the same time, the layers of this tape amalgamate to create a continuous insulation sheath.

Insulation distance

Refer to the table on page 179 (BPM values) to determine the distances between the bars and toward grounding. HVBT tape is sold in 4 different widths and is coated with adhesive on the outer part. Fibreglass tape used to stop taping is provided with each roll.

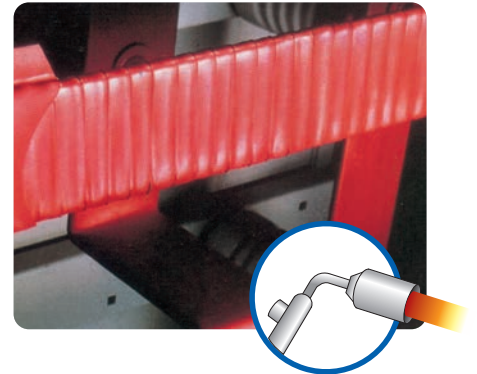

HVBT

Self-sealing heat-shrink tape for MV bar insulation.

Product	Item	Width (mm)	Length (m)
HVBT 12-A	364471-000	25	10
HVBT 14-A	475743-000	50	10
HVBT 15-A	736143-000	75	10
HVBT 16-A	215370-000	100	10



IDENTIFICATION DATA OF APPROPRIATE TERMINATION



TERMINATION

<input type="radio"/> For indoor use	<input type="radio"/> Single core	<input type="radio"/> Copper conductor
<input type="radio"/> For external use	<input type="radio"/> Three-core	<input type="radio"/> Aluminium conductor

NOMINAL VOLTAGE

<input type="radio"/> 6 kV (U _{max} 7,2)
<input type="radio"/> 10 kV (U _{max} 12)
<input type="radio"/> 15 kV (U _{max} 17)
<input type="radio"/> 20 kV (U _{max} 24)
<input type="radio"/> 30 kV (U _{max} 36)

CABLE INSULATION

<input type="radio"/> Extruded cable	<input type="radio"/> Full
	<input type="radio"/> Low
<input type="radio"/> Low thickness insulation	
<input type="radio"/> Belted cable	
<input type="radio"/> 3 lead paper	
<input type="radio"/> 1 lead paper with shielded phases	

ARMOUR

<input type="radio"/> Non armoured
<input type="radio"/> Armoured wire
<input type="radio"/> Armoured tape

SHIELD

<input type="radio"/> Copper wire
<input type="radio"/> Copper tapes
<input type="radio"/> Aluminium tube
<input type="radio"/> Lead sheath

CABLE SECTION

<input type="radio"/> 25 mm²
<input type="radio"/> 35 mm²
<input type="radio"/> 50 mm²
<input type="radio"/> 70 mm²
<input type="radio"/> 95 mm²
<input type="radio"/> 120 mm²
<input type="radio"/> 150 mm²
<input type="radio"/> 185 mm²
<input type="radio"/> 240 mm²
<input type="radio"/> 300 mm²
<input type="radio"/> 400 mm²
<input type="radio"/> 500 mm²
<input type="radio"/> 630 mm²
<input type="radio"/> mm ²

TYPE

<input type="radio"/> Self-shrinking
<input type="radio"/> Heat-shrink

INCLUDES GROUNDING BRAID

<input type="radio"/> Yes
<input type="radio"/> No



INCLUDES CABLE TERMINAL

<input type="radio"/> Yes
<input type="radio"/> No



IDENTIFICATION DATA OF APPROPRIATE JUNCTION



NOMINAL VOLTAGE

6 kV (U_{max} 7,2)

10 kV (U_{max} 12)

15 kV (U_{max} 17)

20 kV (U_{max} 24)

30 kV (U_{max} 36)

CABLE DATA 1

CABLE

Single core

Three-core

CONDUCTOR

Copper

Aluminium

CABLE INSULATION

Extruded cable

Belted cable

3 lead paper

1 lead paper with shielded phases

ARMOUR

Non armoured

Armoured **wire**

Armoured **tape**

CABLE SECTION

25 mm²

35 mm²

50 mm²

70 mm²

95 mm²

120 mm²

150 mm²

185 mm²

240 mm²

300 mm²

400 mm²

500 mm²

630 mm²

..... mm²

SHIELD

Copper wire

Copper tapes

Aluminium tube

Lead sheath

INCLUDES CONNECTOR

Yes

No

TYPE

Cold-shrink

Heat-shrink

CABLE DATA 2

CABLE

Single core

Three-core

CONDUCTOR

Copper

Aluminium

CABLE INSULATION

Extruded cable

Belted cable

3 lead paper

1 lead paper with shielded phases

ARMOUR

Non armoured

Armoured **wire**

Armoured **tape**

CABLE SECTION

25 mm²

35 mm²

50 mm²

70 mm²

95 mm²

120 mm²

150 mm²

185 mm²

240 mm²

300 mm²

400 mm²

500 mm²

630 mm²

..... mm²

SHIELD

Copper wire

Copper tapes

Aluminium tube

Lead sheath

INCLUDES CONNECTOR

Yes

No

TYPE

Cold-shrink

Heat-shrink

MEDIUM VOLTAGE TESTING DETAILS FOR TERMINALS AND JOINTS UP TO 36 KV.

TEST	TEST METHOD (VOLTAGES IN KV)	MAXIMUM VOLTAGE PER CABLE UM (KV)					RESULTS
		7,2	12	17,5	24	36	
INDUSTRIAL FREQUENCY AC	a) 1 min. (dry)	27	35	45	55	75	Neither perforations nor discharges
	b) 1 min. (in the rain)	27	35	45	55	75	
	c) 4 h.	14	24	36	48	73	
PARTIAL DISCHARGES	PE, XLPE, EPR, PVC (voltages in kV)	4,5	7,5	10,9	15	22,5	< 3 pC
		7,2	12	17,5	24	-	< 20 pC
IMPULSE	a) 10 positive 10 negative 1,2/50 μ s (voltages in kV)	60	75	95	125	170	Neither perforations nor discharges
	b) 10 positive 10 negative 1,2/50 μ s (voltages in kV)	70	95	110	150	200	
THERMAL CYCLES WITH APPLIED VOLTAGE	a) 63 cycles of 5 h. of heating, 3 h. of air cooling	-	-	-	-	-	Neither perforations nor discharges
	b) 63 cycles of 5 h. of heating, 3 h. of water cooling (1m of water head)	-	-	-	-	-	
	Extruded cable and non-migrant mixture paper cable	9	15	22	30	45	
	Migrant mixture paper cable	6,5	11	15	22	32	
THERMAL SHORT-CIRCUIT TEST	a) short-circuit of 1s f/f at maximum temperature specified for the cable	-	-	-	-	-	No visible damage
	b) short-circuit of 1s f/t at maximum temperature specified for the cable	-	-	-	-	-	
DIRECT CURRENT	30 min	28	48	72	96	144	Neither perforations nor discharges
HUMIDITY TEST WITH APPLIED VOLTAGE	a) 100 h. in saturated air	4,5	7,5	10,9	15	22,5	Neither perforations nor discharges, nor visible carbonisation nor erosion
	b) 1000 h. in saturated air	4,5	7,5	10,9	15	22,5	
DYNAMIC SHORT-CIRCUIT TEST	63 kA - Standard	-	-	-	-	-	No visible damage
	125 kA - High Current	-	-	-	-	-	
IMPACT	Fall from a height of 2 m at a weight of 4 kg, 6 times (only reinforced joints)	-	-	-	-	-	
SALTY FOG TEST WITH APPLIED VOLTAGE	1h of sealing salinity 224 kg/m ³ (voltages in kV)	4,5	7,5	10,9	15	22,5	No discharge

TESTING SEQUENCE

Indoor terminations 1a,2,3a, 4a,2,5, 4a, 1c, 3a,6,7a, 8

Outdoor terminations 1b, 2, 3b, 4a,2, 5,4a, 2, 1c,3b, 6,7b, 8, 10

Joints 9, 1a,2,3b,4a,2,5, 4b,2,5, 4b,2,1c,3b, 6,8

